



**Tabasco**



# USER MANUAL

# Table of Contents

<b>1</b>	<b>Your Device</b> .....	<b>5</b>
1.1	Overview .....	5
1.2	Setting up your phone.....	7
1.3	Powering on your phone.....	9
1.4	Powering off your phone.....	9
<b>2</b>	<b>Phone call</b> .....	<b>10</b>
2.1	Making a Call.....	10
2.2	Answering or rejecting a call .....	11
2.3	Hanging up a call .....	12
<b>3</b>	<b>Contacts</b> .....	<b>12</b>
3.1	Adding a Contact .....	13
3.2	Viewing a Contact.....	13
3.3	Editing a Contact .....	14
3.4	Sharing a Contact.....	14
3.5	Deleting Contacts .....	14
3.6	Import/Export Contacts .....	14
<b>4</b>	<b>Messages</b> .....	<b>14</b>
4.1	Sending a Text Message (SMS) .....	15
4.2	Sending a Multimedia Message (MMS) .....	15
<b>5</b>	<b>Camera</b> .....	<b>16</b>
5.1	Accessing the Camera .....	16
5.2	Take a picture.....	16
5.3	Zoom in/out .....	16
5.4	Accessing the Video .....	16
<b>6</b>	<b>Browser</b> .....	<b>16</b>

<b>7</b>	<b>Multimedia</b> .....	<b>17</b>
7.1	Picture .....	17
7.2	Music.....	18
7.3	Video .....	18
7.4	FM Radio.....	18
7.5	Sound Recorder. ....	19
<b>8</b>	<b>Tools</b> .....	<b>19</b>
8.1	Calendar.....	19
8.2	Calculator .....	20
8.3	Clock .....	21
<b>9</b>	<b>Applications</b> .....	<b>22</b>
9.1	E-Mail .....	22
9.2	File Manager .....	23
9.3	Note.....	24
<b>10</b>	<b>Setting</b> .....	<b>24</b>
10.1	Wireless & Network .....	24
10.2	APPs .....	27
10.3	Sounds .....	27
10.4	Display .....	28
10.5	Battery.....	29
10.6	Storage.....	29
10.7	Accessibility.....	29
10.8	Privacy & Security .....	30
10.9	Software Update.....	30
10.10	System .....	31
<b>11</b>	<b>Safety and Precautions</b> .....	<b>31</b>
11.1	Device Precautions.....	31

11.2	Battery Precautions .....	32
11.3	FCC Notice and Cautions .....	33
11.4	Consumer Information on SAR .....	33
11.5	FCC Hearing-Aid Compatibility (HAC) Regulations for Wireless Devices .....	35
11.6	Limited Warranty Period .....	36
11.7	Copyright Information .....	38

# 1 Your Device

## 1.1 Overview

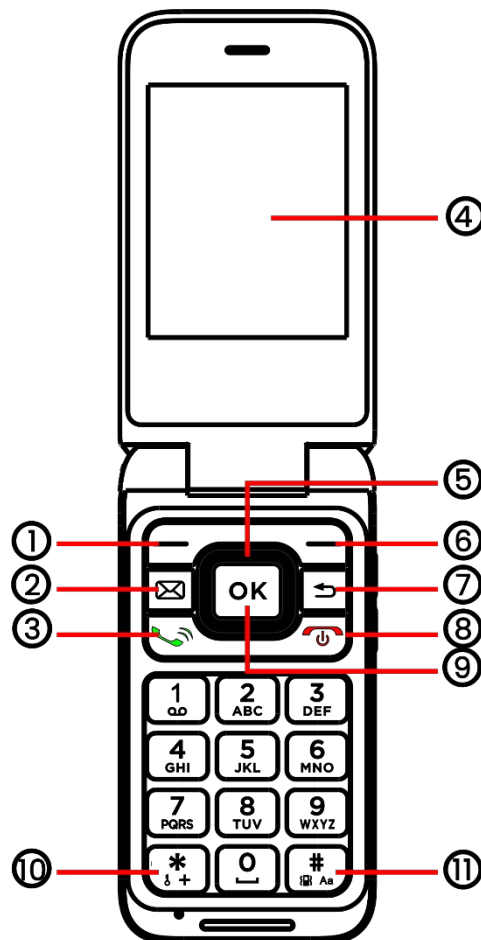
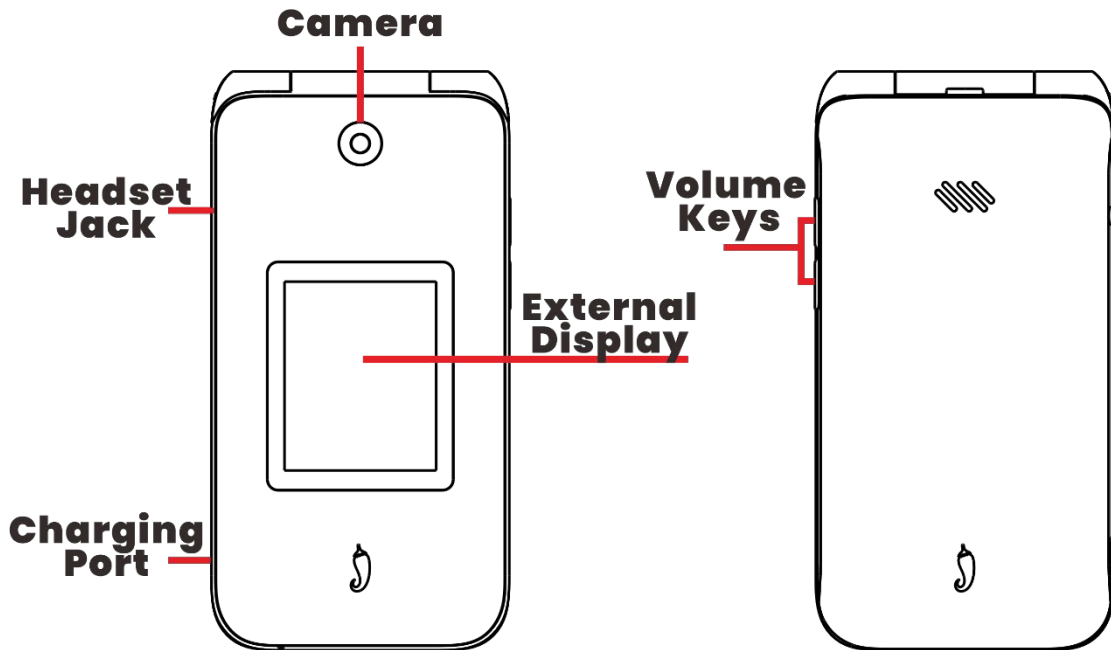

## ① Left Soft Key

- Press to access Notifications in Home Screen
- Multifunction key within Applications and Menus

## ② Messages

- Press to access messages

## ③ Call Key

- Make a call
- Press to Enter call log in Home Screen

## ④ Internal display

## ⑤ Navigation Key (up, down, left, right)

- Press to change selections up, down, left, and right
- Press Right: Access Camera / Video
- Press Left: Access Pictures
- Press Up: Access Website
- Press Down: Access Settings

## ⑥ Right Soft Key

- Press to access Contacts in Home Screen
- Press to access Options within Applications and Menus

## ⑦ Back/Delete Key

- Move backwards through Menus
- Delete previous input

## ⑧ End/Power Key

- Press to End a call, and return to the main screen

- Press and hold to Power on/off

## ⑨ Center Soft Key (OK Key)

- Press to access Applications list in Home Screen
- Confirm and select options

## ⑩ Key symbols

- Press to choose a \* or + symbol. Press the **Center Soft Key** to Lock the device.

## ⑪ Letters symbols

- In Home Screen, press to toggle vibrate.
- During keypad input, press to switch between numbers, upper case letters lower case letters, and predictive text. Press and hold to select a language.

## 1.2 Setting up your phone

Your phone may not have any SIM card pre-installed. MicroSD cards excluded as well. Optional microSD Memory Cards are supported (up to 128GB).

**NOTE:** Power off the device before opening the back cover to install a microSD Memory Card or replace the nano-SIM card.

**Step 1.** With the device facing down, remove the back cover from the bottom left corner. Use your fingernail to carefully lift the cover away from the device body.

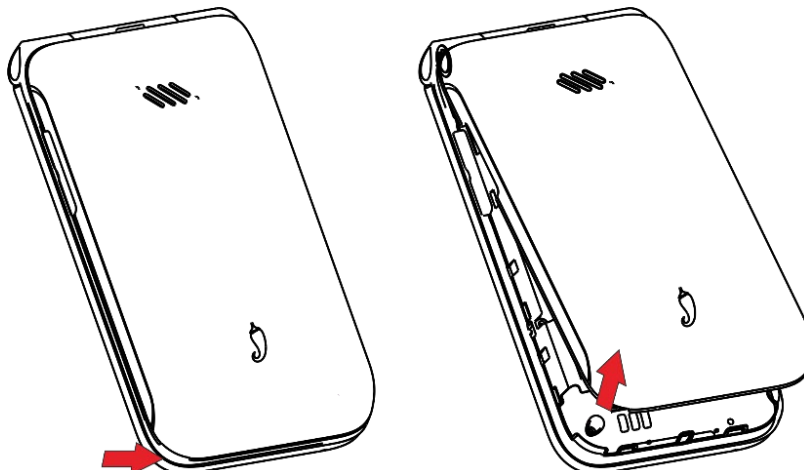

**Step 2.** Remove the battery using your fingernail to lift from the top.

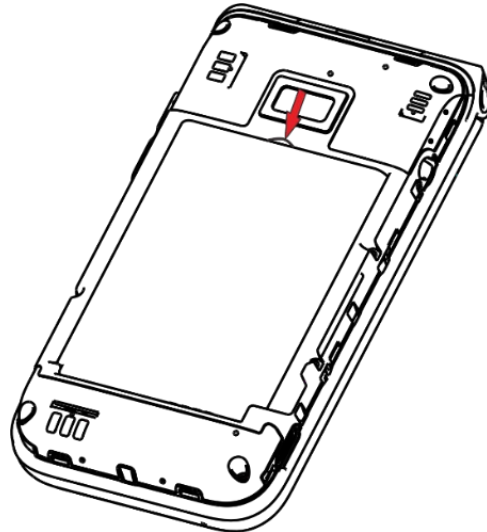

**Step 3.** To insert SIM card ① or microSD card ②, push the SIM card or microSD card into the card slot with the gold-colored contacts facing down.

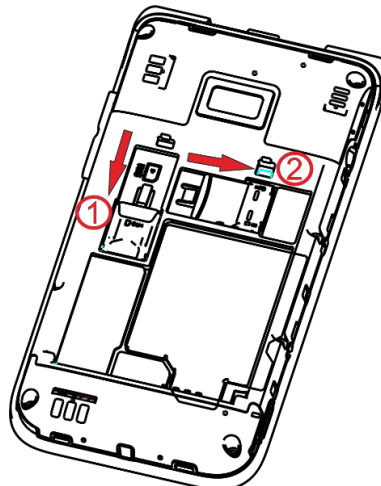

To remove the SIM card or microSD card, press down on the small plastic tab, then slide out the card. Do not use force or any sharp objects.

**Step 4.** Re-install the battery by aligning the gold contact points of the

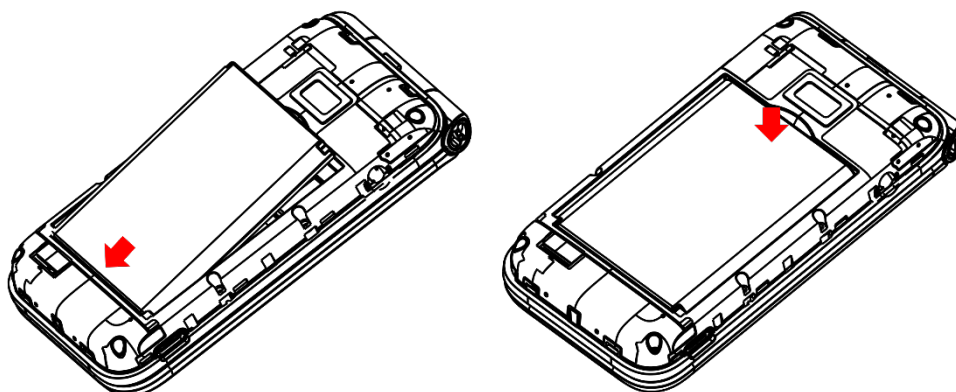



battery with the gold contact points of the compartment. It only fits one way. Press down to position in place.

**Step 5.** Carefully align the back cover with tabs and press into place. It only fits one direction.

**Step 6.** Charge your phone fully before powering it on and starting the setup process.

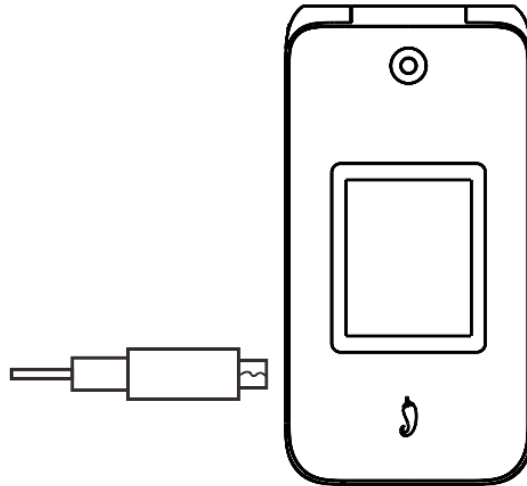

**WARNING:** Only use the charger and cable supplied with the phone. Using incompatible chargers or tampering with the charging port could damage your phone.

## 1.3 Powering on your phone

Press and hold the **End/Power Key**  until the phone powers on.

### Setup your phone for the first time

The first time you power on the phone, you will be guided through the setup process. Additional settings can be configured in Settings:

- Select the phone's language, then press the **Right Soft Key**  to go to the next step.
- You will see the Home Screen



**Note:** Even if no SIM card is installed, your phone will still power on and you will be able to connect to a Wi-Fi network and use some of the phone's features.

## 1.4 Powering off your phone

Press and hold the **End/Power Key** , until the phone vibrates and powers off.

# 2 Phone call

## 2.1 Making a Call

Dial the desired number then press the **Call Key**  to make the call. If you make a mistake, you can delete the incorrect digits by pressing the **Back/Delete Key** .

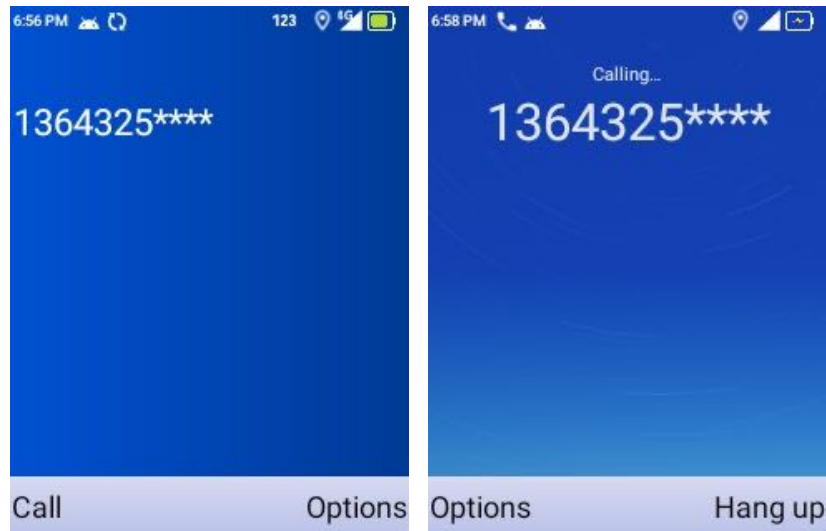

You can also press the **Left Soft Key**  to call

Press the **Right Soft Key**  to show more **Options**

1. Create new contact
2. Add to a contact
3. Send a message
4. Settings
5. Add 2-sec pause
6. Add wait
7. Call history

### a) Make a call from your call log

From the Home Screen, press the **Call Key** .

Enter the **Call Log** to access the call log and choose the contact you want to dial, then press the **Call Key** .

### b) Make a call from Contacts



From the Home Screen, press the **Right Soft Key** , Choose the contact

you want to dial, then press the **Call Key** .

### c) Making an emergency call

If your phone has network coverage, dial the Emergency Number and press the **Call Key**  to make an Emergency Call. This works even without a SIM card or PIN code.

### d) Make an international call

To dial an international call, press and hold  to enter “+” in the dial screen, then enter the international country prefix followed by the full phone number, then press the **Call Key** .

### e) Calling your voicemail

Press and hold  key to call and listen to your voicemail.

### f) Setting up voicemail

1. Press and hold the  key to call into your voicemail system.
2. Follow the prompts for setup instructions.

### g) Checking voicemail

From your phone:

1. Press and hold the  key to call into your voicemail system.
2. Follow the prompts.

From other phones:





1. Dial your wireless number.
2. When you hear the greeting, press  to interrupt.
3. Follow the instructions. Contact your operator to confirm service availability.

**NOTE:** Your voicemail inbox is not protected until you create a passcode by following the setup prompts. Voicemail may not be available in some areas. Follow the setup instructions to password protect your voicemail inbox.

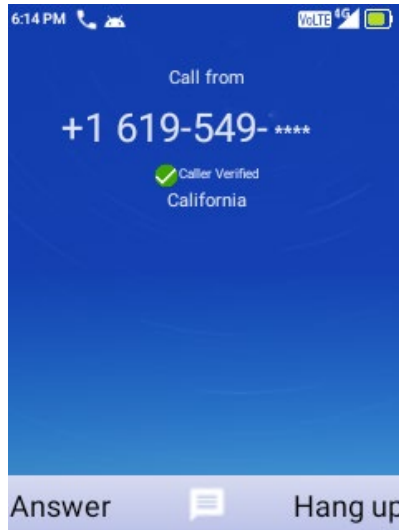
## 2.2 Answering or rejecting a call

During an incoming call:



- Open the flip to answer, if **Flip open to answer** is On. Otherwise,
- Press the **Left Soft Key** , or **Call Key**  to answer.
- Press the **Right Soft Key**  or the **End/Power Key**  to Hang up.
- Press the **Center Soft Key**  to reject the call by sending a preset message.
- To mute the ringtone during an incoming call, press the **Volume Up/Down Key**.

## 2.3 Hanging up a call

During a call:

- Open the flip and press the **End/Power Key**  to end the call.
- Open the flip and then close the flip to end the call.

## 3 Contacts

**Contacts** enables quick and easy access to the contact you want to reach.

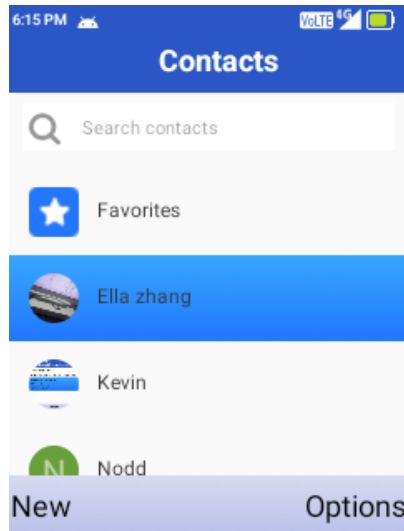

From the Home Screen, press the **Center Soft Key**  and select **Contacts** to enter the contact list.

### 3.1 Adding a Contact



On the Contacts screen, Press **Left Soft Key**  to create a **New Contact** and enter the contact information.

When finished, press the **Left Soft Key**  to save.

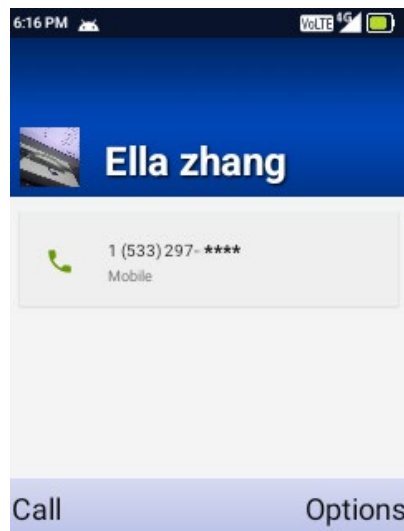

### 3.2 Viewing a Contact

On the Contacts screen, use the **Navigation Key** to select a Contact, then press the **Center Soft Key**  to access the contact's details.



- Press the **Left Soft Key**  or **Center Soft Key**  to make a call.
- Press the **Right Soft Key**  to access the **Options**: Send a message, Edit, Delete and Share.

### 3.3 Editing a Contact

On the Contacts screen, using the **Navigation Key** to select a Contact, then press the **Right Soft Key**  to access **Options**, select **Edit contact** and press the **Center Soft Key**  to edit.

When finished, press the **Left Soft Key**  to save.

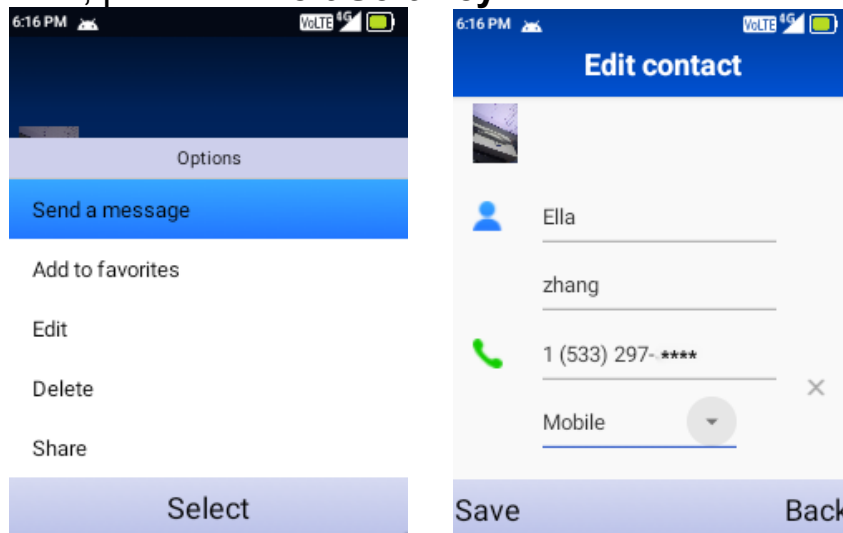



### 3.4 Sharing a Contact

You can share a single contact with others by sending the contact's vCard to them via Email, Messages, or Bluetooth.

On the Contacts screen, use the **Navigation Key** to select a Contact, then press the **Right Soft Key**  to access **Options**, and then select **Share**.

### 3.5 Deleting Contacts



On the Contacts screen, use the **Navigation Key** to view available contacts and the **Center Soft Key**  to make your selection, and then press the **Right Soft Key**  to select **Delete**.

### 3.6 Import/Export Contacts



On the Contacts screen, press the **Right Soft Key**  to access **Options**.

- Select **Import contacts** to import contacts from internal storage to phone.
- Select **Settings > Export contacts** to export contacts from phone to internal storage.





## 4 Messages

Press the **Messages**  Key, or from the Home Screen, press the **Center Soft Key**  and select Messaging  to enter **Messages**.

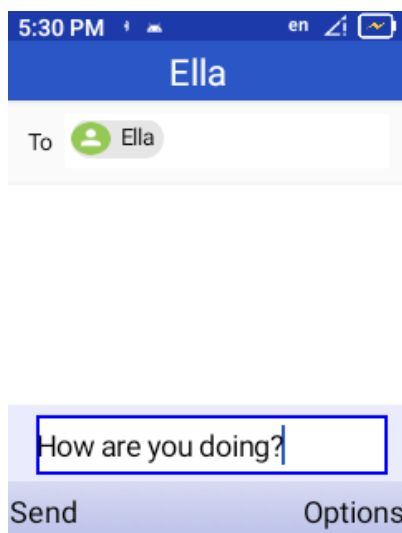
## 4.1 Sending a Text Message (SMS)

Press **Left Soft Key**  **New** to create a new message, input desired phone number and message. Press **Left Soft Key**  to send out.



- Press the **Left Soft Key**  to write a new message.
- Enter the phone number of the recipient in the “To:” bar or press the **Left Soft Key**  to add recipients.
- Use the **Navigation Key** to go to the **SMS/MMS** message entry bar to enter the content of the message.
- Press  Key to switch between the different input methods.
- Press  Key to select symbols.
- Press the **Left Soft Key**  to send messages.

## 4.2 Sending a Multimedia Message (MMS)

Press the **Right Soft Key**  to access **Options**.

MMS enables you to send multimedia content including videos, pictures, photos, contacts and sounds to other compatible phones.

An SMS will be converted to MMS automatically when media files (image, video, audio, etc.) are attached or email addresses are added.

An SMS of more than 160 characters will be charged as multiple SMS messages. Special characters may reduce the total available character length

of each SMS message. This may cause an increase in the number of SMS messages sent to your recipient.

## 5 Camera

Your mobile phone features Photo and Video capture ability.

### 5.1 Accessing the Camera

To access this function, press the **Center Soft Key**  from the Home Screen and select Camera.

### 5.2 Take a picture

Position the object or scene in the screen and press the **Center Soft Key**  to take the Photo. Photos will be automatically saved to the Multimedia application under Picture.

After taking a Photo, press the **Left Soft Key**  to preview.

### 5.3 Zoom in/out

Press Up or Down of the **Navigation Key** to zoom in and out.

Press the **Right Soft Key**  to access options, and press Left or Right on the **Navigation Key** to toggle available options:

- Camera Resolution: Select the resolution as 2M, 1M.
- Self-Timer: Sets a delay for Photo capture after pressing the **Center Soft Key**

### 5.4 Accessing the Video

- Press Left and Right on the **Navigation Key** to switch between Photo and Video mode.
- Press Up or Down of the **Navigation Key** to zoom in and out.
- Press the **Center Soft Key**  to record a Video, and press again to stop recording. Videos will be automatically saved to the Multimedia application under Video.

## 6 Browser



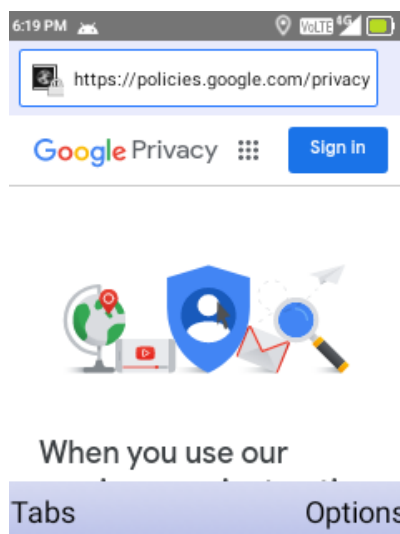

To access this function, press the **Center Soft Key**  from the Home Screen and select browser

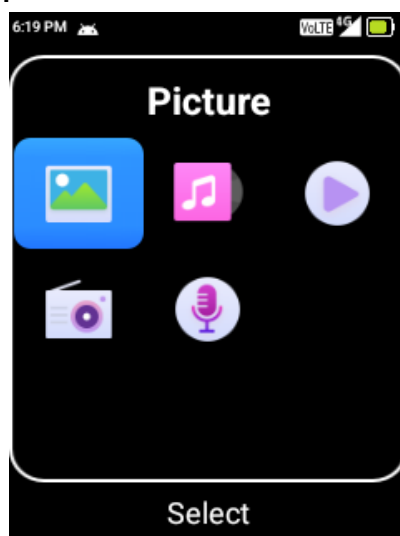

## 7 Multimedia

The Multimedia application provides you with Pictures, Music, Video, FM Radio, Sound recorder.



To access this application, press the **Center Soft Key**  from the Home Screen and select Multimedia.

Press the **Navigation Key** to switch application function that you want.

### 7.1 Picture

The Multimedia Picture app provides you with one location to view and organize all your saved photos.

To access this function, press the **Center Soft Key**  from the Home Screen and select **Multimedia > Picture**.

Press the **Navigation Key** to select the picture list.

Use the **Navigation Key** to select an image and press the **Center Soft Key**

 to confirm, then press the **Right Soft Key**  to access options below:

- **Delete:** Delete the selected photo.
- **Edit:** Select this option to rotate or crop the photo.
- **Share:** Share the photo via Messages or Bluetooth.
- **Select Multiple:** Allows you to select several photos in the Gallery.
- **Details:** Displays the file path, size and resolution.
- **Set as:** Set the photo as Wallpaper or Image for existing contact.



## 7.2 Music

To access this function, press the **Center Soft Key**  from the Home Screen and select Multimedia > Music. Using this menu, you can play music files stored on phone storage in your phone. Music files can be downloaded from your computer to phone using a USB cable.

## 7.3 Video

Video acts as a media player for you to view videos.

To access this function, press the **Center Soft Key**  from the Home Screen and select **Multimedia > Video**

- Use the **Navigation Key** to select a video, press the **Center Soft Key**  to play the video.
- Press the **Right Soft Key**  to access Options.

## 7.4 FM Radio





Your phone is equipped with an FM radio. You can use the application as a traditional radio with saved stations or with parallel visual information related to the radio program on the display if you tune to stations that offer Visual Radio service.

To access this function, press the **Center Soft Key**  from the Home Screen and select **Multimedia > FM Radio**.

To use it, you must plug in your wired headset, which works as an FM receiving antenna. FM Radio performance may reduce when using headphones with shielded audio cables.

## 7.5 Sound Recorder.

To access this function, press the **Center Soft Key**  from the Home Screen and select **Multimedia > Sound Recorder**.

- Press the **Center Soft Key**  to start recording and press the **Center Soft Key**  to end recording.
- Press the **Right Soft Key**  and use the **Navigation Key** to select the recording, then press the **Center Soft Key**  to play.
- Press the **Right Soft Key**  to access Options, such as delete, share, rename or details.

## 8 Tools

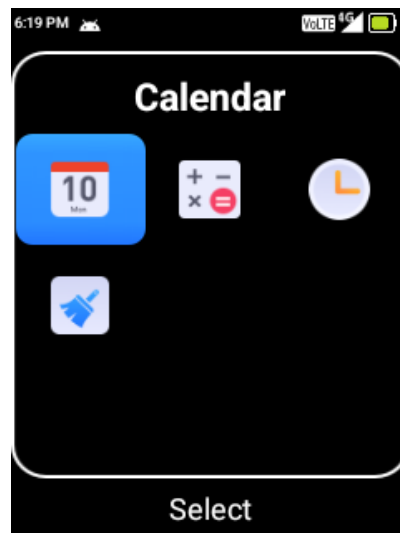

### 8.1 Calendar

Use the Calendar to keep track of important meetings, reminders or appointments.

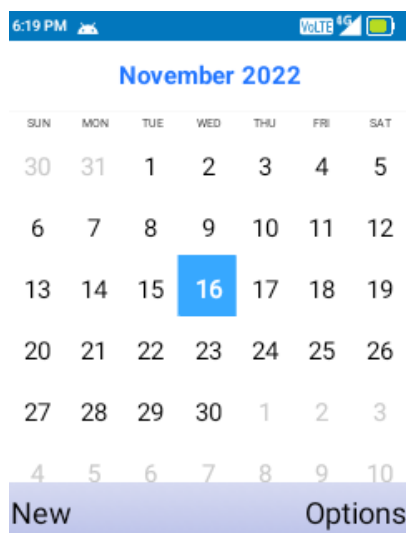

To access this function, press the **Center Soft Key**  from the Home

Screen and select **Tools > Calendar**.







### a) Create New Event

Press the **Left Soft Key**  to add new events from any Calendar view.

- Fill in all required information for a new event. If it is a whole day event, you can press the **Center Soft Key**  to select **All-day**.
- When finished, press the **Left Soft Key**  to save.

### b) Delete and Edit Event

After new event is created, under Month view or Day view, use the **Navigation Key** to move to the event. Press the **Center Soft Key**  to show the events list, then press the **Right Soft Key**  to delete or press the **Left Soft Key**  to edit.

More options are available by pressing the **Right Soft Key**  from the Calendar main screen:

- **Today:** Quickly navigate to the current day.
- **Settings:** Configure Calendar settings.





### c) Event reminder

If a reminder is set for an event, the upcoming event will appear on the Status bar as a notification when the event time arrives.

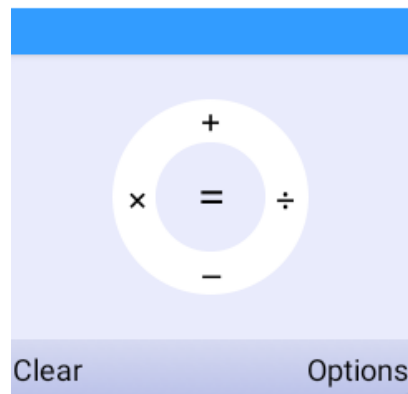
## 8.2 Calculator

To access this function, press the **Center Soft Key**  from the Home Screen and select **Tools > Calculator**



- **0-9 key:** Input numbers
-  **key:** “.”
- **Navi key:** +, -, X, ÷
-  **:** =
- **Left Soft Key**  : Clear
- **Right Soft Key**  : Options

## 8.3 Clock

To access this function, press the **Center Soft Key**  from the Home Screen and select **Tools > Clock**

Press **Navigation Key (Left, Right)** to switch between Alarm, Timer, Stopwatch, Clock.

### a) Set Alarm

Press the **Right Soft Key**  to add a new alarm. Select Hour, Minutes, AM/PM, then press OK.



For additional settings, press **Left Soft Key**  to Edit. The following options will appear:

- **Turn alarm on:** Toggle on/off alarm.
- **Time:** Select to set the alarm time.
- **Repeat:** Select the days you want your alarm to go off.
- **Alarm sounds:** Select a ringtone for the alarm.
- **Delete Alarm:** Delete an alarm.





Press the **Back Key**  **Save** and go back.

## b) Set Timer



Press the **Navigation Key** (Up, Down) to select and edit hours, minutes and seconds. When finished, press the **Center Soft Key**  to start the Timer.

- When the Timer is ongoing, press the **Center Soft Key**  to pause and continue the Timer.
- When the Timer is paused, press the **Left Soft Key** , to reset the Timer.

## c) To Set the Stopwatch

- Press the **Center Soft Key**  to start Stopwatch.
- When the Stopwatch is ongoing, press the **Right Soft Key**  to record the lap, press the **Center Soft Key**  to pause the time.
- When the Stopwatch is paused, press the **Center Soft Key**  to continue the total time, press the **Left Soft Key** , to reset the stopwatch and clear lap times.

## d) Clock

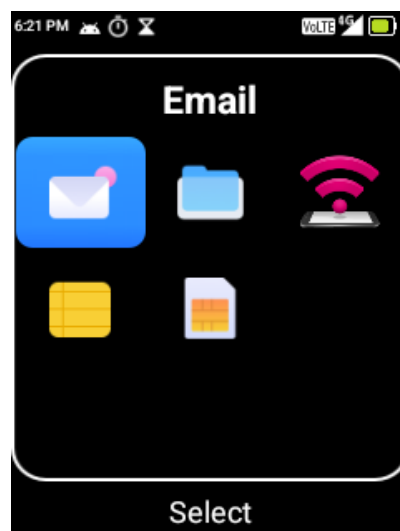

- press the **Left Soft Key** , for ALL to select the world time of each region. Press **Back Key**  to check all selected times.

# 9 Applications



## 9.1 E-Mail







## a) Setup E-Mail

You can access this function by pressing the **Center Soft Key**  from the Home Screen, select Applications and select **E-Mail** .

Email account setup will guide you through the steps to set up an email account. Select next to continue.

- Enter the name and email for the account you want to set up.
- Press the **Navigation Key** and select **NEXT** to continue to the next step. If the account you entered is not provided by your service provider in the phone, you will be prompted to manually setup your email.
- To add another email account, press the **Right Soft Key**  to access **Options > Settings**, then select **Add**.

## b) Send E-Mail

- Press the **Left Soft Key**  to compose a new email from the Inbox screen.
- Enter recipient(s) email address(es) in the To field, then press the **Center Soft Key**  to confirm and add new recipient(s).
- Type the subject and the content of the message. You may use your voice to enter the subject and content of your emails by pressing and holding the **Center Soft Key**  button.
- If necessary, press the **Right Soft Key**  to Add cc/bcc or Add attachments to the message.
- If you do not want to send the mail right away, you can press the **Right Soft Key**  and select **Save as draft** to save a copy.
- When ready to send, press the **Left Soft Key**  to send.

## 9.2 File Manager

From the Home Screen press the **Center Soft Key** , select **Applications** and select **File Manager**.

File Manager displays all data stored on the phone and the microSD Memory Card, including applications, downloaded media files, content from other locations, videos, pictures or audio you have captured, and any other data





transferred via Bluetooth, USB Cable or by network.

When you download an application from PC to phone/microSD card, you can locate the application using File Manager, then select it to install it in your phone.

File Manager allows you to perform and be efficient with the following common operations create (sub) folders and open view, rename, move, copy, delete, play, and share saved files.

## 9.3 Note

Press the **Center Soft Key**  from the Home Screen, select Applications and select **Note**

- Press the **Left Soft Key**  to add a new note, then enter contents, then press the **Left Soft Key**  to **Save**.
- On the notes list, press the **Right Soft Key**  to access **Options**, such as delete, share and select notes.
- Use the **Navigation Key** to select the note, and press the **Center Soft Key**  to view details or edit. Press the **Right Soft Key**  to delete or share the note via Email, Messages or Bluetooth.

## 10 Setting

From the Home Screen press the **Center Soft Key** , select Settings . You will the following options:

### 10.1 Wireless & Network

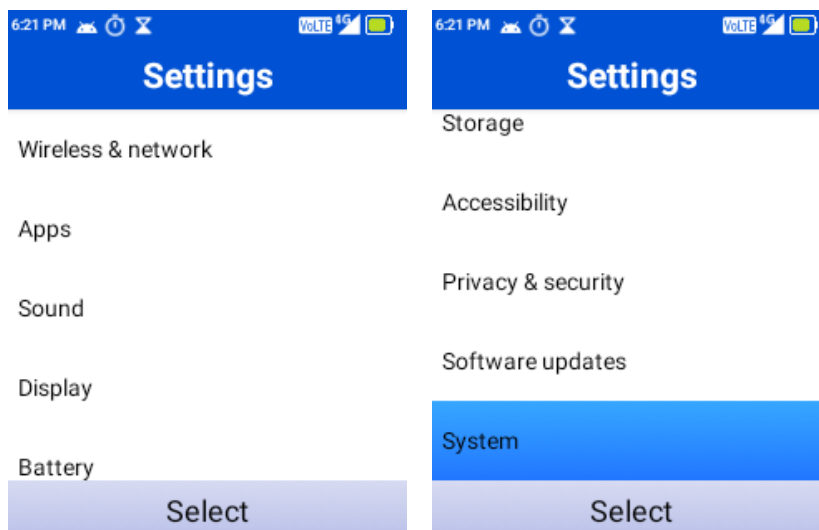





Select Wireless & Network and press **Center Soft Key**  to access.



## a) Wi-Fi

Wi-Fi will allow you to surf the internet without using your mobile network when in range of a wireless network.





Press the **Center Soft Key**  to enter **Wi-Fi**.

- Press the Up and Down of the **Navigation Key** to select **On**, then press the **Center Soft Key**  to turn on Wi-Fi.
- Press the Up and Down of the **Navigation Key** to select **Available networks**, then press the **Center Soft Key**  to enter the available networks list, select one and press the **Center Soft Key**  to configure the access point and connect your phone. Be advised you may need to enter a password if applicable.
- Press the Up and Down of the **Navigation Key** to select **Wi-Fi preferences** and **Saved networks**, then press the **Center Soft Key**  to set more options.

## b) Bluetooth

Bluetooth allows your phone to exchange data (videos, images, music, etc.) with other Bluetooth devices within a close range such as another phone, computer, printer, headset, etc.

Press the **Center Soft Key**  to enter **Bluetooth**.

- Press the Up and Down of the **Navigation Key** to select **On**, then press the **Center Soft Key**  to turn on Bluetooth.
- Use Bluetooth: Press the **Center Soft Key**  to turn on/off.
- Device Name: Press the **Center Soft Key**  to enter, edit the name then press the **Navigation Key** to select **RENAME** to save.
- **Pair Devices**: Press the **Center Soft Key**  to enter nearby devices list, using the Up and Down of the **Navigation Key** to select a needed device, press the **Center Soft Key**  to confirm.

## c) Mobile Network

Press the **Center Soft Key**  to enter **Mobile network**.

- **Mobile data**: Access data using mobile network. Press **Center Soft**

Key  to turn on/off

- **Roaming:** Connect to data services when roaming. Press **Center Soft Key**  to turn on/off.
- **APP data usage:** Access and see each APP data usage value.
- **Data warning & limit:** Access and set the data warning on/off, data limit on/off, data limit value.
- **Preferred network type:** Access and set LTE type.
- **Wi-Fi calling:** To disable and enable Wi-Fi calling.

## d) Airplane Mode

When Airplane mode is on, all wireless connections are disabled simultaneously, including Wi-Fi and Bluetooth.

- Press the **Center Soft Key**  to turn on/off.

## e) Tethering and Mobile Hotspot

- **Mobile Hotspot:** Turn your phone into a portable Wi-Fi Hotspot so you can share your mobile data connection with other devices.

Press the **Center Soft Key**  to turn on/off.

Note: First time to set, you need to set the spot name and password, then save. Not necessary after first setting.

- **USB tethering:** Connect your phone to a computer using the USB cable and turn on the USB tethering to share the data connection.

Note: Only once USB is connected can this feature be activated.

- **Mobile Hotspot Setting:** Setting Hotspot name, password, Maximum connections, and preferred channel.
- **Mobile Hotspot turn off timer:** Access and select by pressing **Center Soft Key**  and set an idle time to turn off the hotspot.

## f) Data Saver

Data Saver feature can be turned on or off by the user. If it is on, application performance may be enhanced for low- or no-data access.

## g) USB

There are several modes for to select from, including Charging only, File transfer, USB tethering, MIDI, PTP and No data transfer.

## **h) 10.1.8 VPN (Virtual Private Network)**

Press the **Left Soft Key**  to add a new VPN.

Enter the required VPN information and when finished, select Save.

## **i) Files received via Bluetooth**

This showed the details of transferring history through Bluetooth.

## **10.2 APPs**

All applications will be listed here whether they are from System or Downloaded. Press **Navigation Key** to select and **Center Soft Key**  to access. Open, Disable and Force stop are available options.

**Notifications:** Turn on/off to toggle application notifications.

## **10.3 Sounds**

### **a) To adjust Volume:**

- Call Volume: Press the Volume Up/Down button on the right side of the device to adjust the Ringtone & Alerts volume. You can also use the **Navigation Key (Left, Right)**
- Ring & notification & alarm: Press the **Navigation Key (Left, Right)**

### **b) To adjust ringtones**



- Press the **Center Soft Key**  to access.
- Press the **Navigation Key (Up, Down)**
- Press OK to save.

### **c) Sound > Tones.**

- Under Tones, you may select your preferences on Vibrate, Ringtones, Notification Alerts and Manage Tones.
- Press the **Center Soft Key**  to confirm.

### **d) To adjust Other Sounds**

All other sounds that are related to Dial Pad or Camera can be adjusted by doing the following:



- From the Home Screen, press the **Center Soft Key** , select  **Settings > Sound > Other Sounds.**

## 10.4 Display



### a) To adjust Brightness

- From the Home Screen, press the **Center Soft Key** , select **Settings > Display.**
- Press the **Navigation Key** to select Brightness.
- Select desired brightness by pressing the Left or Right of the **Navigation Key.**



### b) To adjust Wallpaper

- From the Home Screen, press the **Center Soft Key** , select  **Settings > Display > Wallpaper.**
- Press Picture to select from Images that are stored on your device.
- Press Camera to take a picture for the Wallpaper you would like to use/store.
- Press Wallpapers to select from pre-loaded Wallpapers.



### c) To adjust Screen timeout

- From the Home Screen, press the **Center Soft Key** , select  **Settings > Display > Screen timeout.**
- Select when you would like your screen to turn off, then press the **Center Soft Key**  to confirm.



### d) To adjust Key backlight timeout

- From the Home Screen, press the **Center Soft Key** , select  **Settings > Display > Key backlight timeout.**
- Select when you would like your screen to turn off, then press the **Center Soft Key**  to confirm.



### e) Change font size

- From the Home Screen, press the **Center Soft Key** , select  **> Display > Font size**
- Go down to the bottom, press **Navigation Key (Left, Right)** select small, default, large or largest. Press back to save.



## f) Change Display size

- From the Home Screen, press the **Center Soft Key** , select  **Settings > Display > Display size**
- Go down to the bottom, press **Navigation Key (Left, Right)** select small or default. Press back to save.

## 10.5 Battery



From the Home Screen, press the **Center Soft Key** , select  **Settings > Battery**

At the top of the page, battery capacity percentage remaining will be seen.



- **Battery usage:** To see an overview of your battery level and activity for the last 24 hours.
- **Use battery manager:** Press **Center Soft Key**  to toggle detection when apps are draining battery.
- **Battery percentage:** Press **Center Soft Key**  to show battery percentage in the status bar.



## 10.6 Storage

From the Home Screen, press the **Center Soft Key** , select  **Settings > Storage**.



- **This Device:** Press the **Center Soft Key**  to access and select SD card or This device.
- **Free up space:** Press the **Center Soft Key**  to access and free up space.

## 10.7 Accessibility

From the Home Screen, press the **Center Soft Key** , select  **Settings > Accessibility**

- **Vibration:** press the **Center Soft Key**  to turn on/off Ring vibration and Notification vibration
- **TTY Mode:** Press the **Center Soft Key**  to select TTY off, TTY full,



TTY HCO, TTY VCO.

- **RTT mode:** Press the **Center Soft Key**  to turn on/off RTT calls.
- **Audio adjustment:** Press the **Center Soft Key**  to turn on/off Mono audio. Press **Navigation Key (Left, Right)** to modify audio balance.

## 10.8 Privacy & Security

### a) Lock/Unlock your screen

To protect your phone and privacy, you can lock the phone screen by creating a password.

- From the Home Screen, press the **Center Soft Key** , select  **Settings > Privacy & security > Screen lock**. Select Pin to set lock password. Select None to cancel PIN locking.

### b) Device admin apps

Activating this admin app will allow the app file manager to perform the following operations:

- Change the screen lock
- Set password rules
- Lock the screen

### c) SIM Security

A SIM PIN prevents access to the SIM card cellular data networks. When it's enabled, any device containing the SIM card will request the PIN upon restart. A SIM PIN is not the same as the lock code used to unlock the device.

## 10.9 Software Update

To access Software Updates, follow the steps below:



- Connect your device to a Wi-Fi network and make sure it has a strong data connection.
- Ensure your battery is fully charged before starting the software update. Your device's current battery level can be found on your device under **Settings > Software Update > Check for updates**
- When there is a new mandatory software update version available, the phone will start downloading automatically. Select Continue to update

your system.

## 10.10 System

### a) Language & input

Your device can be operated using English and Spanish language.

- From the Home Screen, press the **Center Soft Key**  , select   
**Settings > System > language**
- Press the **Navigation Key** to select the desired language preference.
- Press the **Center Soft Key**  to confirm.

### b) Date & Time

From the Home Screen, press the **Center Soft Key**  , select   
**Settings > System > Date & Time**

#### a) Set time automatically:

- Use network-provided time: Time will be set according to your SIM network information.
- Use GPS-provided time: Time will be set according to your location information.
- Off: Turn off time setting automatically. Only on “Off”, you can set date and time manually.

b) Automatic time zone: Press **Center Soft Key**  to toggle on/off.

c) **Select time zone:** Press **Center Soft Key**  to select the zone according to the location.

**Note:** Only when Automatic time zone is “Off”, you can select the time zone manually.

d) Use Locate default & Use 24-hour format: Press **Center Soft Key**  to toggle on/off the default or individual selection.

# 11 Safety and Precautions

## 11.1 Device Precautions

This mobile phone is well designed with detail. Please exercise special care when using it. The following suggestions will help your mobile phone survive the warranty period and extend its expected service life:

- a) Keep the mobile phone and all its accessories beyond children's reach.
- b) Keep the mobile phone dry. Keep away from rain, moisture, liquid or other substances that may corrode electronic circuits.
- c) Do not use or store the mobile phone in a dusty place to avoid damaging the device.
- d) Do not store the mobile phone in a high temperature place. High temperature will shorten the life of electronic circuits and damage the battery and some plastic parts.
- e) Do not store the mobile phone in a cold place. Moisture may collect inside the mobile phone and damage electronic circuits when the mobile phone is moved to a warmer environment.
- f) Do not throw, knock or shock the mobile phone, as that may damage the internal circuits and high-precision components of the mobile phone.
- g) Do not puncture, disassemble or cause a short-circuit in the battery.
- h) Do not burn or dispose of a used battery in household rubbish or store it at temperatures above 140°F (60°C).
- i) The operating temperature for the phone is 14°F (-10°C) to 131°F (55°C). The charging temperature for the phone is 32°F (0°C) to 104°F (40°C).

## **11.2 Battery Precautions**

- a) Do not disassemble, open, crush, bend, deform, puncture or shred.
- b) Do not modify or remanufacture, attempt to insert foreign objects into the battery, immerse or expose to water or other liquids, expose to fire, explosion or another hazard.
- c) Only use the battery with a charging system that has been qualified with the system per CTIA Certification Requirements for Battery System Compliance to IEEE 1725. Use of an unqualified battery or charger may present a risk of fire, explosion, leakage or another hazard.
- d) Replace the battery only with another battery that has been qualified with the system per this standard, IEEE-STD-1725. Use of an unqualified battery may present a risk of fire, explosion, leakage or another hazard.
- e) Promptly dispose of used batteries in accordance with local regulations.
- f) Avoid dropping the phone or battery. If the phone or battery is dropped, especially on a hard surface, and the user suspects damage, take it to a



service center for inspection.

g) Improper battery use may result in a fire, explosion or other hazards.

## **11.3 FCC Notice and Cautions**

This device and its accessories comply with Part 15 of FCC Rules. Operation is subject to the following conditions:

- This device and its accessories may not cause harmful interference.
- This device and its accessories must accept any interference received, including interference that may cause undesired operation.

Part 15.21 Statement:

Changes or modifications that are not expressly approved by the manufacturer could void the user's authority to operate the equipment.

Part of Statement 15.105:

This equipment has been tested and found to comply with the limits for a class B digital device, pursuant to Part 15 of the FCC Rules. These limits are designed to provide reasonable protection against harmful interference in a residential installation. This equipment generates, uses, and can radiate radio frequency energy and, if not installed and used in accordance with the instructions, may cause harmful interference to radio communications. However, there is no guarantee that interference will not occur in a particular installation. If you experience interference with reception (e.g., television), determine if this equipment is causing the harmful interference by turning the equipment off and then back on to see if the interference is affected.

If necessary, try correcting the interference by one or more of the following measures:

- Reorient or relocate the receiving antenna.
- Increase the separation between the equipment and receiver.
- Connect the equipment into an outlet on a circuit different from that to which the receiver is connected.
- Consult the dealer or an experienced radio/TV technician for further assistance.

## **11.4 Consumer Information on SAR**

This Model Phone Meets the Government's Requirements for Exposure to Radio Waves. Your wireless phone is a radio transmitter and receiver. It is designed and manufactured not to exceed the emission limits for exposure to radiofrequency (RF) energy set by the Federal Communications Commission (FCC) of the U.S. Government. These FCC exposure limits are derived from the recommendations of two expert organizations, the National Council on Radiation Protection and Measurement (NCRP) and the Institute of Electrical and Electronics Engineers (IEEE). In both cases, the recommendations were developed by scientific and engineering experts drawn from industry, government, and academia after extensive reviews of the scientific literature related to the biological effects of RF energy. The exposure limit for wireless mobile phones employs a unit of measurement known as the Specific Absorption Rate, or SAR.

The SAR is a measure of the rate of absorption of RF energy by the human body expressed in units of watts per kilogram (W/kg). The FCC requires wireless phones to comply with a safety limit of 1.6 watts per kilogram (1.6 W/kg). The FCC exposure limit incorporates a substantial margin of safety to give additional protection to the public and to account for any variations in measurements. Tests for SAR are conducted using standard operating positions specified by the FCC with the phone transmitting at its highest certified power level in all tested frequency bands. Although SAR is determined at the highest certified power level, the actual SAR level of the phone while operating can be well below the maximum value. Because the phone is designed to operate at multiple power levels to use only the power required to reach the network, generally, the closer you are to a wireless base station antenna, the lower the power output. Before a phone model is available for sale to the public, it must be tested and certified to the FCC that it does not exceed the limit established by the government adopted requirement for safe exposure. The tests are performed in positions and locations (e.g., at the ear and worn on the body) as required by the FCC for each model. This device was tested for typical body-worn operations with the back of the phone kept 0.39 inches (1.0 cm) between the user's body and the back of the phone. To comply with FCC RF exposure requirements, a minimum separation distance of 0.39 inches (1.0 cm) must be maintained between the user's body and the back of the phone. Third-party belt clips, holsters, and similar accessories containing metallic components should not be used.

Body-worn accessories that cannot maintain 0.39 inches (1.0 cm) separation

distance between the user's body and the back of the phone and have not been tested for typical body-worn operations may not comply with FCC RF exposure limits and should be avoided.

The FCC has granted an Equipment Authorization for this model phone with all reported SAR levels evaluated as in compliance with the FCC RF emission guidelines.

The highest SAR value for this model phone when tested for use at the head is **1.084 W/kg** and when worn on the body, as described in this user's manual, is **1.189 W/kg**. While there may be differences between SAR levels of various phones and at various positions, they all meet the government requirement for safe exposure. SAR information on this model phone is on file with the FCC and can be found under the Display Grant section of <http://www.fcc.gov/oet/ea/fccid/> after searching on FCC ID: 2A33N-L62A. To find information that pertains to a particular model phone, this site uses the phone FCC ID number which is usually printed somewhere on the case of the phone. Sometimes it may be necessary to remove the battery pack to find the number. Once you have the FCC ID number for your phone, follow the instructions on the website and it should provide values for typical or maximum SAR for that phone.

Additional information on Specific Absorption Rates (SAR) can be found on the Cellular Telecommunications Industry Association (CTIA) website at <http://www.ctia.org/>

In the United States and Canada, the SAR limit for mobile phones used by the public is 1.6 watts/kg (W/kg) averaged over one gram of tissue. The standard incorporates a substantial margin of safety to give additional protection for the public and to account for any variations in measurements.

## **11.5 FCC Hearing-Aid Compatibility (HAC) Regulations for Wireless Devices**

This device has been tested and rated for use with hearing aids, with some of the wireless technologies that it uses. However, there may be newer wireless technologies used in the device that have not been tested yet for use with hearing aids. It is important to try the different features on your device thoroughly and in different locations whilst using a hearing aid or

cochlear implant to determine if there is any interfering noise.

The FCC has adopted HAC rules for digital wireless phones. These rules require certain devices to be

tested and rated under the American National Standard Institute (ANSI) C63.19-2011 hearing aid compatibility standards. The ANSI standard for hearing aid compatibility contains two types of ratings:

- M-Ratings: Phones rated M3 or M4 meet FCC requirements and are likely to generate less interference to hearing devices than mobile devices that are not labelled. M4 is the better/higher of the two ratings.
- T-Ratings: Phones rated T3 or T4 meet FCC requirements and are likely to work better with a hearing device's telecoil ("T Switch" or "Telephone Switch") than unrated phones. T4 is the better/ higher of the two ratings. (Note not all hearing devices have telecoils in them.)
- The tested M-Rating and T-Rating for this device are **M4 and T4**.

## 11.6 Limited Warranty Period

Your device has been designed to provide you with reliable, worry-free service. If for any reason you have a problem with your equipment, please refer to the manufacturer's warranty in this section.

### Warranty Information

Hot Pepper Mobile, Inc. ("HP") warrants this device is free from defects in material and workmanship under normal use and service for twelve (12) months commencing upon the date of purchase by the first consumer purchaser. If proof of purchase cannot be provided, the manufacturing date as recorded by HP, based upon the serial number, will be deemed to be the start of Limited Warranty Period.

### Limited Warranty Statement

The consumer should never attempt to open or disassemble the device and doing so may cause damage that voids your warranty. The device is equipped with a rechargeable battery that is removable. This warranty does not cover defects for or resulting from:

Improper or unreasonable use or maintenance;

Failure to follow operating instructions; accident; excess moisture; insects; lightning; power surges; connections to improper voltage supply;

Unauthorized alteration or modification of original condition;  
Damages caused by inadequate packing or shipping procedures;  
Devices purchased from unauthorized dealer;  
Devices whose mechanical serial number or electronic serial number has been removed altered or defaced.

During the Limited Warranty Period, HP will, at its sole option (using new or refurbished replacement parts), repair any defective devices. Repaired devices will be warranted for a period equal to the remainder of the original Limited Warranty on the original device or for ninety (90) days following the date to repair is completed, whichever is longer. All replaced parts, components, boards, and equipment shall become the property of HP. The Limited Warranty is good only to the original purchaser of the device during the Limited Warranty Period as long as it remains in the United States and is not transferable or assignable.

## **Disclaimer of Warranties**

Exclusion of Liability Except as set forth in the Limited Warranty contained on the warranty page enclosed with the device, the purchaser takes the device "AS IS" and HP makes no express or implied warranty of any kind whatsoever with respect to the product or its fitness for any particular purpose or use; the design, condition or quality of the device; the performance of the product; the workmanship of the product or the components contained therein; or compliance of the product with the requirements of any law, rule, specification or contract pertaining thereto.

Nothing contained in the instruction guide shall be construed to create an express or implied warranty of any kind whatsoever with respect to the device. In addition, HP shall not be liable for any damages of any kind resulting from the purchase or use of the device or a rising from the breach of the Limited Warranty, including incidental, special, or consequential damages, or loss of anticipated profits or benefits.

Further, HP shall not be liable for the delay in rendering services under the Limited Warranty or loss of use during the time the device is being repaired. HP is not liable for performance issues or incompatibilities caused by your editing of registry settings, or your modification of operating system software

or any other similar editing, modification, or the like to the device.

HP disclaims liability for removal or reinstallation of the product, for geographic coverage, for inadequate signal reception by the antenna or for communications range or operation of the cellular system. When sending your wireless device to HP for repair or service, please note that any personal data or software stored on the device may be inadvertently erased or altered. Therefore, we strongly recommend you make a backup copy of all data and software contained on your device before submitting it for repair or service. This includes all contact lists, downloads (i.e., third-party software applications, ringtones, games, and photos) and any other data added to your device.

In addition, if your wireless device utilizes a multimedia card, please remove the card before submitting the device, and store for later use when your device is returned. HP is not responsible for and does not guarantee restoration of any third-party software, personal information or memory data contained in, stored on, or integrated with any wireless device, whether under warranty or not, returned to HP for repair or service.

## **Customer Service and Warranty Claims**

For help with your device or its features, or if you have any questions, please call customer service at 1-855-339-8081 from 8:30am-6:30pm ET, Monday-Friday Please have your device in front of you when you call.

## **11.7 Copyright Information**

©2022 Hot Pepper Mobile, Inc. All rights reserved. Other marks are the property of their respective owners. The Mobile name, signature and the logo are registered trademarks of Hot Pepper Mobile, Inc.